

STONE TECHNOLOGY



COMPLETE RANGE OF NEXT GENERATION MACHINES FOR STONework

CMS Stone Technology creates cutting-edge solutions in the marble and natural and composite stone processing sector. Under the Brembana Macchine brand, CMS Stone Technology was in the 1980s the **first manufacturer of a stone machining center**, thanks to an idea from founder Pietro Aceti. CMS Stone Technology has always been a reliable technological partner in designing unique solutions for any requirement in the world of **construction, architecture, interior and exterior decoration** and **wherever the use of stone and marble artifacts is needed**.

*"Machines don't matter -
what matters are the needs of our customer"*

Pietro Aceti, CMS founder

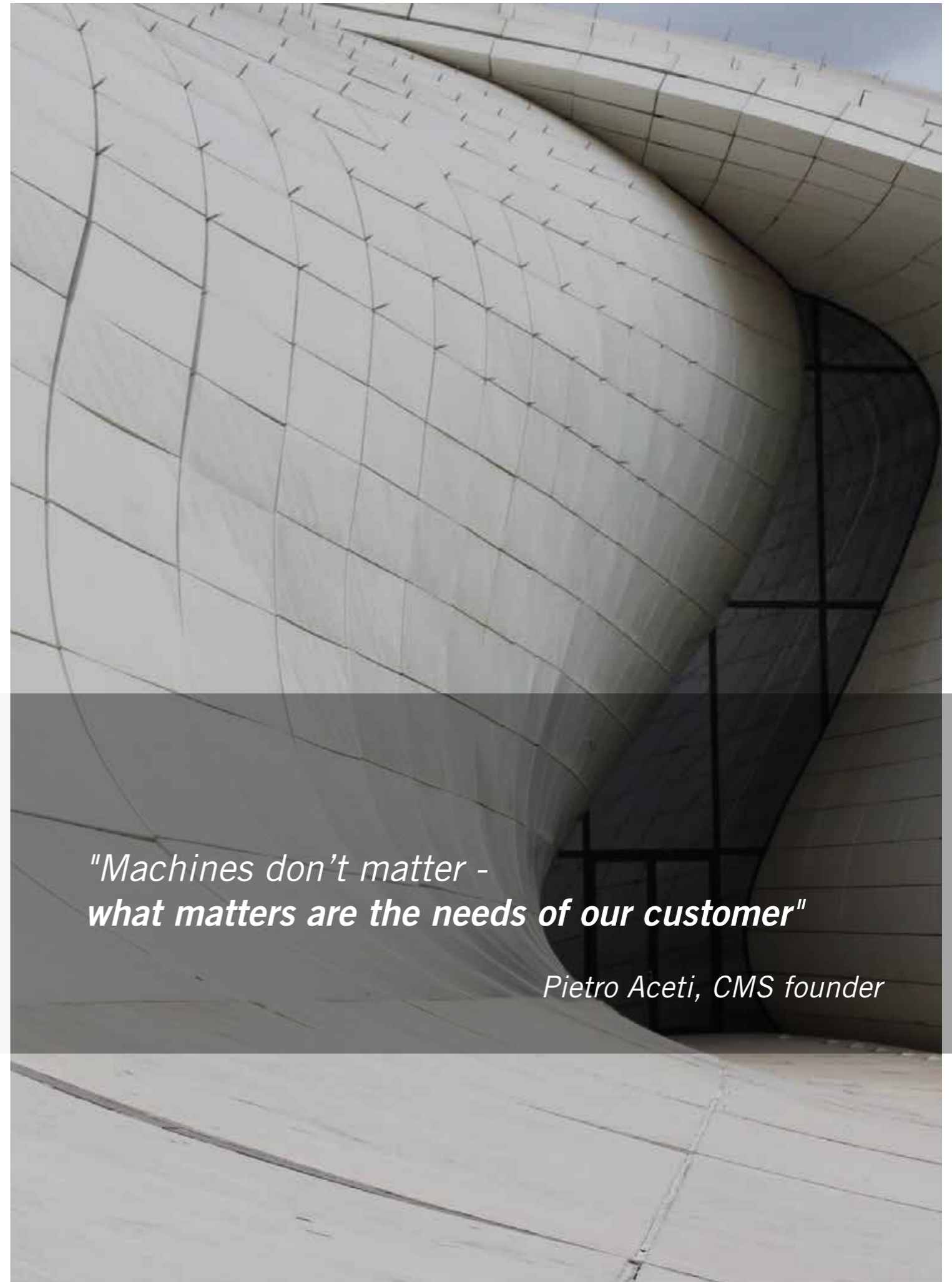

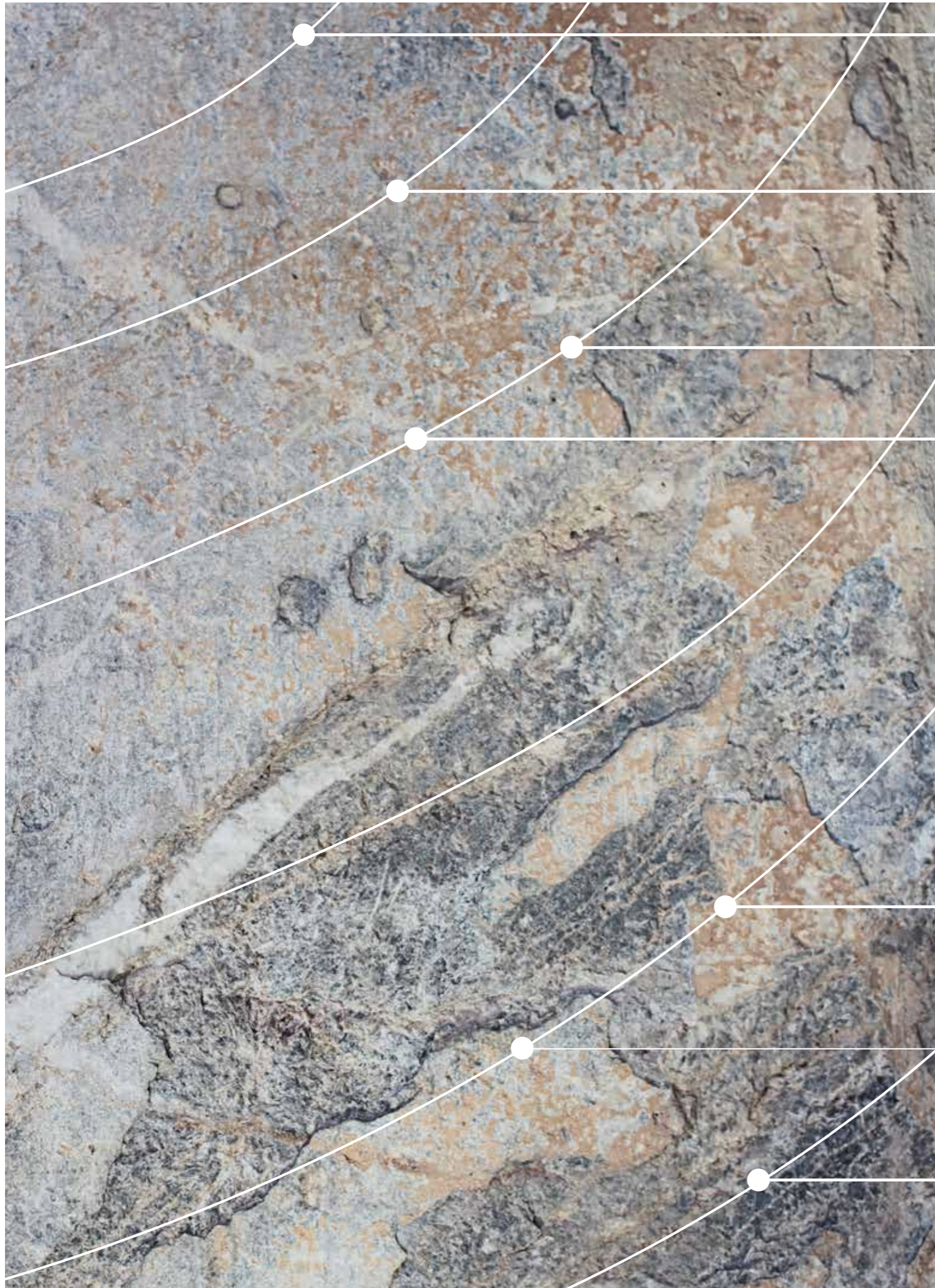

1969

CMS is established. CMS stands for **Costruzione Macchine Speciali (Manufacturing of Special Machines)**. The company introduces itself to the market as a manufacturer of traditional machine tools, powered by mechanical, pneumatic or hydraulic systems.

1985

CMS, under the Brembana brand, builds the **world's first machining center for stone processing**.

1987

CMS North America opens up in Grand Rapids, USA.

2015

SCM Group, which by 2002 had already acquired 51% of CMS, takes over the remaining company shares. **CMS therefore becomes 100% part of the Group** guaranteeing international solidity and coverage.

THE FUTURE OF CMS HOLDS THE DESTINATION OF A CONTINUOUS JOURNEY WHICH BEGAN IN **1969**. THIS IS BASED UPON TWO KEY ELEMENTS: AN IN-DEPTH UNDERSTANDING OF **CUSTOMER NEEDS** AND A HIGH DEGREE OF SPECIALIZATION TO PROVIDE UNIQUE **ADDED VALUE** TO OUR CUSTOMERS' MANUFACTURING PROCESSES.

2017

CMS **doubles its production capacity** with the opening of a **new production center**, PLANT Z, located in Zogno (Bergamo).

2018

Diversified Machine System joins CMS.

2020

The **new technology center** is inaugurated in Zogno (Bergamo).

ARCHITECTURE



INTERIOR DESIGN



CONSTRUCTION



SCULPTURAL ART



UNIQUE SOLUTIONS FOR ANY NEED

CMS Stone Technology works with companies and research centers operating in sectors where efficiency, versatility and high quality performances are essential requirements. CMS Stone Technology machines make it easier to continuously respond to the increasingly complex processing requests of extremely demanding sectors such as **architecture, interior design, construction, sculptural art** and **many others**.

STREET FURNITURE



CMS STONE TECHNOLOGIES

Highly specialized **numerical control work centers, milling machines and water jet cutting systems**, specifically designed for the processing of stone materials. The wide range of machines ensures CMS Stone Technology is capable of meeting the needs of all its customers.

TECHNOLOGIES FOR THE PROCESSING OF STONE MATERIALS

- A. WORK CENTERS
- B. MILLING MACHINES
- C. WATER JET CUTTING SYSTEMS
- D. SOLUTIONS FOR AUTOMATION

CMS DIGITAL SYSTEMS

CMS accompanies its customers through the whole production process, combining **machines with software solutions** and digital services, always with a view to **performance improvement** to optimize business productivity. CMS software solutions are developed to ensure their compatibility with the company's pre-existing software, to **optimize machine use** and the process at large.

DIGITAL SOLUTIONS

- 1. CMS CONNECT
- 2. CMS ACTIVE

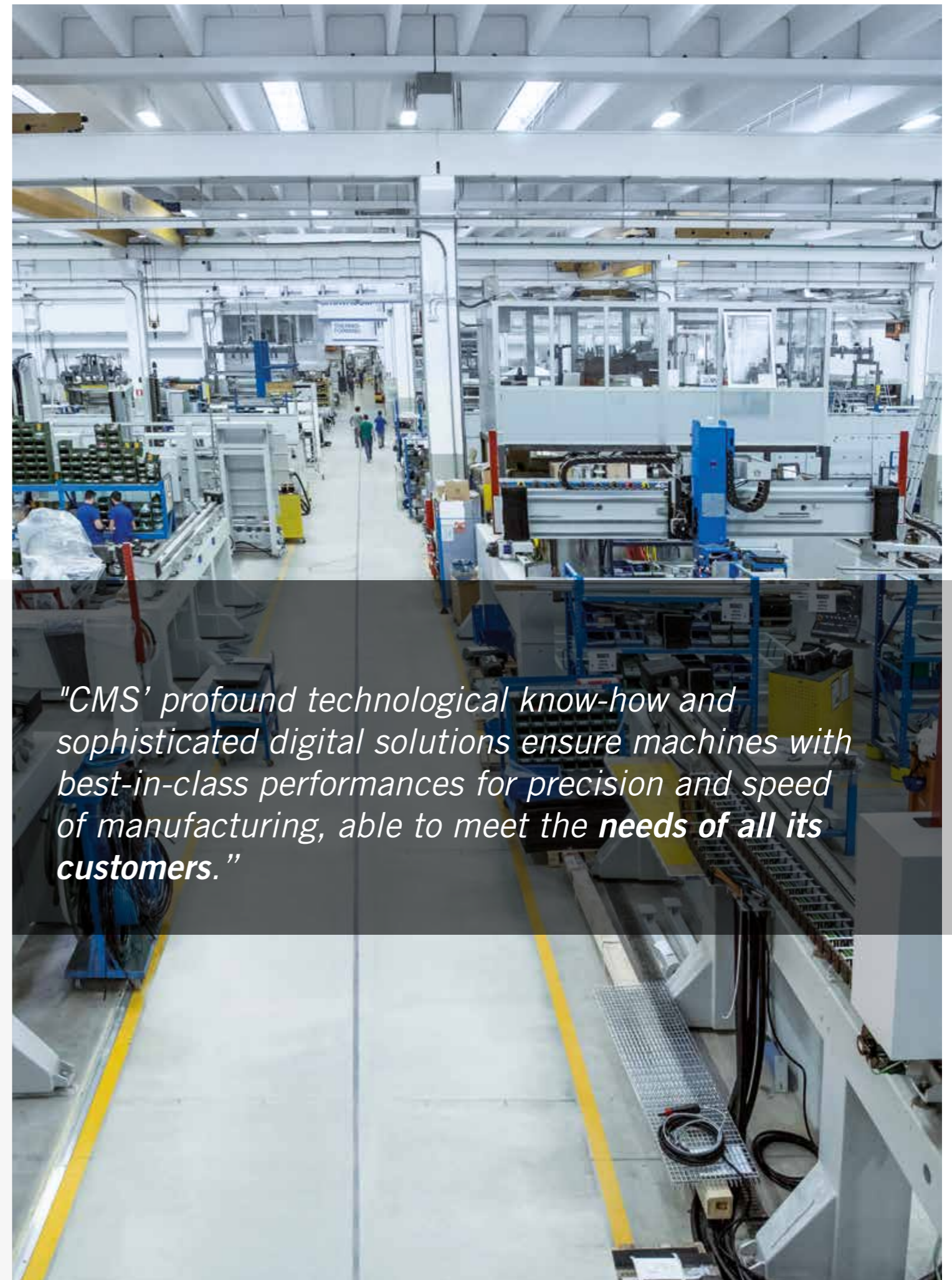

*"CMS' profound technological know-how and sophisticated digital solutions ensure machines with best-in-class performances for precision and speed of manufacturing, able to meet the **needs of all its customers.**"*

- A. Work centers
- B. Milling machines
- C. Water jet cutting systems
- D. Solutions for automation



A. WORK CENTERS

3/4/5 and 6 axis work centers for processing slabs and blocks of **marble, synthetic stone granite** and **ceramic**, including those with very high thickness. These machines can quickly and accurately perform any type of **raw or polished edge contouring, milling, drilling, countersinking, hollowing, bas-reliefs and writing**. The advanced design of its structures, result of CMS Advanced Materials' continuous investments in research and development, and the sophisticated technological solutions adopted provide rigidity, precision over time, speed and flexibility, to guarantee an exceptional level of finishing and an incomparable accuracy.



UNBEATABLE MECHANICS

The powerful structure of these work centers ensures optimal absorption of the stresses deriving from the machining, **ensuring constant high precision over time**. The bases are fixed directly to the ground, thus avoiding the need to carry out masonry works, and increase the **stability and performance of the machines**.

BEST-IN-CLASS POWER

Liquid-cooled electrospindles of CMS design and production with power up to 30 kW, which guarantee **optimal conditions of use and savings of up to 21% on cycle times**.

FINISH WITHOUT COMPROMISE

Tool wear control systems that allow you to automatically adapt the position of the tool to ensure an **excellent quality finish**.

- A. Work centers
- B. Milling machines**
- C. Water jet cutting systems
- D. Solutions for automation



B. MILLING MACHINES

CMS Stone Technology milling machines are CNC work centers with five interpolated axes and are available in both **standard configuration** and equipped with an abrasive water jet cutting head. These machines allow you to perform any type of processing on granite, synthetic stone and ceramic slabs, as well as stone blocks, such as cuts (straight or shaped, vertical or inclined), 3D profiling and hollowing. The milling machines equipped with an abrasive water jet cutting head, working in combination with the diamond disc, allow the cutting of natural and composite stone slabs to be automatized when there are interfering cuts and internal angles. These machines are highly configurable and designed to meet all machining needs while ensuring high productivity.



MAXIMUM FREEDOM FOR YOUR PROJECTS

The rotary axes are **fully interpolated** with linear axes: the machines can therefore, if required, **perform 5-axis machining with tool and/or disc.**

+33% PRODUCTIVITY WITHOUT MANUAL MOVEMENTS

Thanks to suction cup systems, it's possible to automatically move the cut pieces to **optimize the cutting of the slab and reduce processing waste.**

LIMITLESS TECHNOLOGY

5-axis waterjet cutting heads with IKC technology. Effective movement of the heads to make perfect inclined cuts by controlling the taper and deflection of the cutting groove.

- A. Work centers
- B. Milling machines
- C. Water jet cutting systems**
- D. Solutions for automation

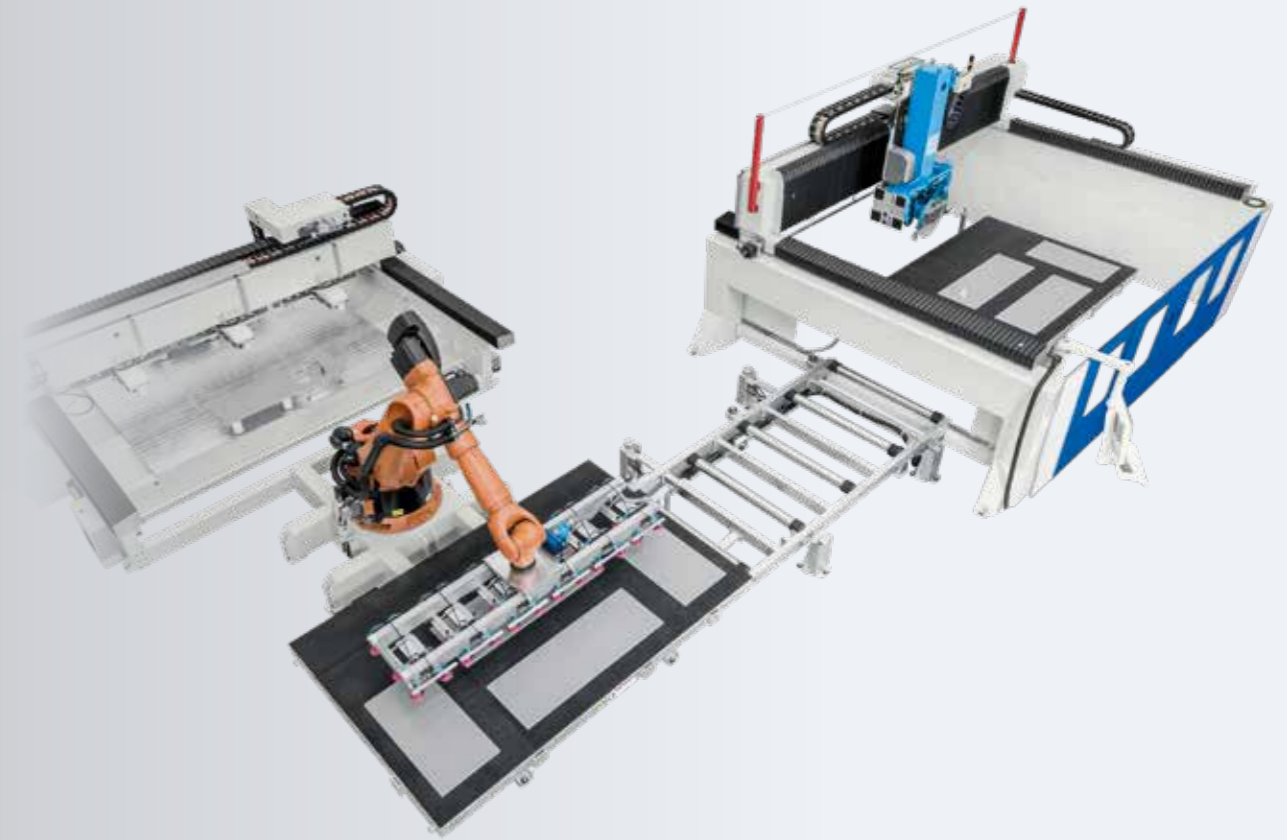

C. WATER JET CUTTING SYSTEMS

CMS Stone Technology offers a wide range of **complete systems for water jet cutting and pressure intensifiers**. Thanks to CMS Tecnocut's profound **know-how** in this technology the machines offered represent the perfect solution for a wide range of applications. These solutions best combine the **cutting power of the high pressure water jet with the reliability of robust, modular structures with large work surfaces** able to guarantee best-in-class positioning accuracy and repeatability.



INFINITE OPPORTUNITY: SAVINGS OF UP TO 33% IN CYCLE TIME

Infinite rotation cutting heads which guarantee a 33% reduction in the cutting cycle, eliminating the need to recover C axis revolutions to align cables and pipes.

ZERO MAINTENANCE

The **monolithic bases** in stainless steel with integrated Evo4 dredging chain systems, for the removal of exhausted abrasive, **reduce maintenance costs by 91%**.

LOADING ERGONOMICS: SMART OPERATION

Maximum loading ergonomics, compact monolithic structures and open frames to simplify the loading and unloading of the machined pieces.

D. SOLUTIONS FOR AUTOMATION

CMS offers **comprehensive automation solutions**, from design planning to delivery of the finished production line

- Integration with **all types of CMS machines**
- **Turnkey solutions**
- Integration with any **peripheral devices** connected to the process
- **Customised solutions** optimised for your process



Modular and flexible robotised island for greater productivity



Automatic loading and unloading systems for continuously operating cutting lines

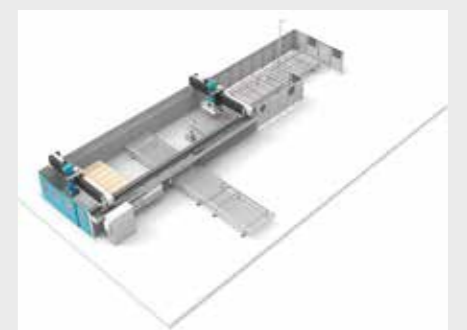

Double bridge cutting lines to separate the primary cutting phase from the following unloading



CMS

Digital Systems

CMS DIGITAL SYSTEMS

Smart software and digital services to improve the productivity of companies working in the advanced materials sector.

CMS accompanies its customers through the whole production process, combining machines with software solutions and digital services, always with a view to increasing performance and optimizing productivity.

CMS software solutions are developed to ensure their compatibility with the company's pre-existing software, to optimize machine use and the process at large.



CMS



1. CMS CONNECT IS THE IOT PLATFORM PERFECTLY INTEGRATED WITH THE LATEST-GENERATION CMS MACHINES

CMS Connect is able to offer customized micro services through the use of IoT apps that support the daily activities of industry operators, improving the availability and use of machines and systems. Real-time data collected by the machines becomes useful information **to increase machine productivity, reduce operational and maintenance costs and cut energy costs.**

SMART MACHINE: continuous monitoring of machine operation, with information on:

STATUS: machine status overview. This allows the machine availability to be checked to identify potential bottlenecks in the production flow;

MONITORING: instantaneous, live display of the operation of the machine and its components, currently running programs and potentiometers;

PRODUCTION: list of machine programs run within a given time frame with best time and average running time;

ALARMS: active and historical warnings.

SMART MAINTENANCE

This section provides a first approach to predictive maintenance, by sending notifications when the machine components report a potentially critical state associated with reaching a certain threshold. This way, it will be possible to intervene and schedule maintenance interventions without interrupting production.

SMART MANAGEMENT

Section dedicated to KPI presentation for all the machines connected to the platform.

The indicators provided assess the availability, productivity and efficiency of the machine and the product quality.

MAXIMUM SECURITY

Use of the standard OPC UA communication protocol, which guarantees the encryption of data at Edge interface level. Cloud and DataLake levels meet all the state-of-the-art cyber-security requirements. Customer data is encrypted and authenticated, to ensure complete protection of sensitive information.

ADVANTAGES

- Optimization of production performances
- Diagnostics to support the optimization of component warranty
- Productivity increase and downtime reduction
- Improvement of quality control
- Reduction of maintenance costs

2. CMS ACTIVE A REVOLUTIONARY INTERACTION WITH YOUR CMS MACHINE

CMS Active is our new interface. The operator can easily manage different machines, as the CMS Active interface software maintain the same look and feel, icons and interaction approach.

EASE OF USE

The new interface has been especially designed and optimized to be immediately used via touch-screen. Graphics and icons have been redesigned for easy and intuitive navigation.

ADVANCED PRODUCTION ORGANIZATION

CMS Active allows different users to be configured with different roles and responsibilities according to the use of the machine (e.g.: operator, maintenance staff, administrator...).

It is also possible to define the work shifts on the machine and then survey activities, productivity and events that have occurred in each shift.

EXCELLENT QUALITY OF THE FINISHED PRODUCT

With CMS Active, the quality of the finished product is no longer jeopardized by worn-out tools. CMS Active's new Tool Life Determination system sends warning messages when tool life is running out and recommends its replacement at the most appropriate time.







TOOL SET-UP? NO PROBLEM!

CMS Active guides the operator during the tool storeroom set-up phase, also taking into account the programs to be run.



CUSTOMER SERVICE

OUR TECHNICIANS BY YOUR SIDE ANYWHERE IN THE WORLD

-  Training
-  Installation
-  Remote Customer Care (RCC)
-  On-site support
-  Check up, preventive maintenance and calibrations
-  Changes and retrofitting
-  Spare parts

ALL OVER THE USA AND CANADA

- A local distribution presence means we can stay close to our customers, guaranteeing highly specialized technicians who can consistently provide a fast, professional response.
- As our products evolve to stay ahead of the competition, so does our service staff. Because of this, our customer service and products have become the industry's standard for excellence. We provide efficient, reliable, proactive and reactive solutions to your problems.
- Not only to reduce a machine's downtime, but also because effective, innovative solutions create added value and protect the customer's investment.



THE MOST ADVANCED EXPERTISE IN INDUSTRIAL MACHINES AND COMPONENTS

World leader in the field of technologies for the processing of a wide range of materials: wood, plastic, glass, stone, metal and composite materials. The Group's member companies around the world are reliable partners of well-known brands working in several product sectors, including furniture, construction, automotive

to aerospace, boating and plastic materials processing. SCM Group coordinates, supports and develops a system of industrial excellence, organized in 3 highly specialized production centers, with 4,000 employees and a direct presence in 5 continents.

INDUSTRIAL MACHINES

Standalone machines, integrated systems and services designed for processing a wide range of materials.



Technologies for wood processing



Technologies for composites, carbon fiber, aluminum, light alloys, plastic, glass, stone and metal processing



INDUSTRIAL COMPONENTS

Technological components for machines and systems of the Group, third parties and for the mechanical industry.



Electrospindles and technological components



Electrical panels



Carpentry and mechanical machining



Iron castings

SCM GROUP IN A NUTSHELL

€700
million
of consolidated turnover

4,000
employees
in Italy and abroad

3 main
production
centers

5 continents
with direct and
widespread presence

7%
of turnover
invested in R&D



CMS NORTH AMERICA
4095 Karona Ct
Caledonia, MI 49316
Tel. +1 616 698 9970
email: cmssales@cmsna.com

HEADQUARTERS
via A. Locatelli 123,
24019 Zogno (BG) - ITALY
info@cms.it
cms.it

a brand of **scm**group